

anti-flooding valve Stausafe RS, DN 200

Part number: 660206

GTIN: 4001636660206

Rebate group: 3

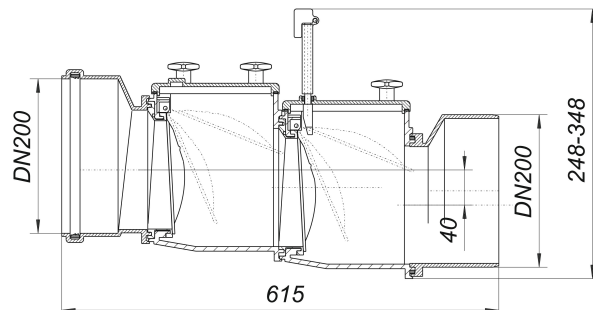
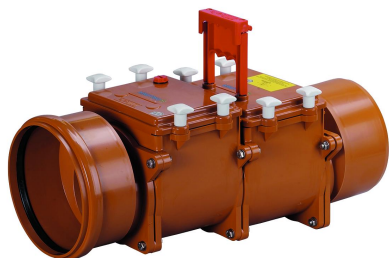

Description:

anti-flooding valve Stausafe RS, DN 200
for EN 13564-1:2002 (DN 100-DN 150), type 2
operation conforms to DIN 1986-100:2002-03

specification:

- twin self-closing stainless steel flaps
- manually operated lock
- stainless steel pivots
- test-port
- easy to maintain ABS housing
- inspection cover with wingnuts can be opened for maintenance without tools

Note: Local regulations outside Germany may allow use on sewage lines.

eg. Document H of the UK Building Regulations.
Dimensions of Dallmer anti-flooding valves on page XXX.

Spare parts:

664020 wing nuts for Stausafe (4 pieces), M 8

664082 grab for Stausafe H and RS, DN 150/ DN

664044 cover seal for Stausafe DN 150/DN 200